

Eklind®



MADE IN U.S.A



Eklind

PRODUCT CATALOG / MARCH 1, 2003



MANUFACTURERS OF HIGH QUALITY
AMERICAN MADE HAND TOOLS
FOR OVER FIFTY YEARS



A USER'S GUIDE TO HEX AND TORX® TOOLS

WHEN YOU NEED	MAY WE SUGGEST	SEE PAGES
The highest quality, industrial grade hex and Torx® key products.	All Eklind brand products will meet your requirements.	ALL
Convenient access to the keys you use most and to avoid losing individual keys.	Fold-up Sets	6 - 9
A comfortable handle that won't slip out of your hand, but you don't want to sacrifice strength.	Ergo-Fold™ Sets	6 - 7
The smallest handle available that will fit conveniently in your pocket.	Classic Fold-Up Sets	8 - 9
Extra torque and / or extra reach.	T-Key Sets or Individuals	20 - 23, 28 - 29
A handle that offers extra torque and reduces the risk of your hands slipping.	Power-T™ Key Sets or Individuals	20 - 21, 28
Tools that are compact and fit readily in your toolbox.	Cushion or Standard Grip T-Key Sets or Individuals	22 - 23, 29
A tool that turns effortlessly in your hand.	Screwdriver Sets or Individuals	19, 30
General purpose Hex and Torx® Tools that you can use in a wide variety of applications.	L-Key Sets and Individuals	10 - 18, 24 - 27
A holder that will keep your keys in the right place, and fits comfortably in your toolbox.	L-Key Sets with Molded Holders	10 - 13
A container that will provide maximum protection for your tools.	L-Key Sets with Metal Box	14 - 15
Tools that will help you to obtain access to hard to reach fasteners.	Ball-End Tools	4 - 11, 14 - 21, 24, 28, 30
A complete assortment of keys, preparing for any project you may encounter.	Combo Sets	4 - 5
Quick access to all of your Hex and Torx® tools so that they are conveniently located on your work bench.	Sets with Stands	19 - 23, 30
A solution to keeping your tool crib organized.	L-Key Organizers	18





Page	Contents	TORX [®]			HEX		
		Ball / Torx [®]	Tamper Resistant	Standard Torx [®]	Ball Hex	Tamper Resistant	Standard Hex
2	User's Guide to Hex and Torx [®] Tools						
4 - 5	Combination Sets			★	⬠		⬠
6 - 7	Ergo-Fold [™] Key Sets		★	★	⬠		⬠
8 - 9	Classic Fold-up Sets			★	⬠		⬠
10 - 11	Ball-Hex-L [™] Key Sets in Molded Holders	★			⬠		
12 - 13	Hex-L [®] Key Sets in Molded Holders		★	★			⬠
14 - 15	Hex-L [®] Keys in Metal Boxes			★	⬠		⬠
16 - 17	Hex-L [®] Keys in Vinyl Pouches	★	★	★		⬠	⬠
18	L-Key Organizers			★	⬠		⬠
19	Ball-Hex Screwdrivers				⬠		
20 - 21	Power-T [™] Key Sets			★	⬠		⬠
22 - 23	Cushion and Standard Grip T-Key Sets						⬠
24	Individual Ball-Hex-L [™] Keys	★			⬠		
25	Individual Torx [®] L-Keys		★	★			
26	Individual Hex-L [®] Keys - Inch					⬠	⬠
27	Individual Hex-L [®] Keys - Metric						⬠
28	Individual Power-T [™] Keys			★	⬠		⬠
29	Individual Cushion & StandardGrip T-Keys						⬠
30	Individual Ball-Hex Screwdrivers				⬠		
31	Replacement Shafts			★	⬠		⬠
32 - 33	Replacement Fold-up Keys			★	⬠		⬠
33	L-Key Holders & Metal Boxes	★	★	★	⬠		⬠
34 - 35	Merchandisers			★	⬠		⬠





COMBO SETS

When you need both inch and metric Hex Keys, an Eklind Combo Pack is the best choice. These sets offer convenience as well as value. Combo sets include popular inch and metric sizes in Ball-Hex and Standard Hex Keys as well as Torx® Keys.

BALL•HEX•L™ KEY SETS

HEX•L® KEY SETS



*Turns 360°
at up to a
35° Angle*



The Industry Standard

ERGO•FOLD™ KEY SETS

CLASSIC FOLD•UP KEY SETS



*Feel the
Difference!*



*Extra Leverage
Extra Torque
Extra Reach*



Eklind® BALL-HEX-L™ COMBO SETS

		KEY SETS					
ITEM NO.	NO. of KEYS	13211	13213	13607	13609	25171	25911
13218	18	Red		Blue			
13222	22		Red		Blue		
29016	16				Blue	Blue	
29022	22		Red				Red



Eklind® HEX-L® COMBO SETS

			KEY SETS					
ITEM NO.	SERIES	NO. of KEYS	10111	10113	10213	10507	10509	10609
10022	L & S	22			Red		Blue	
10222	LONG	22			Red			Blue
10122	SHORT	22		Red			Blue	
10518	SHORT	18	Red			Blue		



Eklind® ERGO-FOLD™ COMBO SETS

		KEY SETS							
ITEM NO.	NO. of KEYS	13213	13609	25161	25171	25581	25611	25911	25912
25013	13			Blue	Blue				
25015	15						Red		Red
25016	16				Blue			Red	
25024	24				Blue	Green		Red	
25028	28			Blue	Blue		Red		Red
25036	36			Blue	Blue	Green	Red		Red
29016	16		Blue		Blue				
29022	22	Red						Red	



Eklind® CLASSIC FOLD-UP COMBO SETS

		KEY SETS		
ITEM NO.	NO. of KEYS	20911	21171	22571
26160	16	Red	Blue	
29171	23	Red	Blue	Green





Eklind®



ERGO-FOLD™ KEY SETS Eklind

ERGO-FOLD™ KEY SETS

Feel The Difference!

Ergo-Fold™ Key Sets feature a composite grip handle shaped for superior ergonomics. A soft cushion-grip insert offers comfort and slip resistance, while a hard shell provides maximum strength. Eklind keys provide extra reach for safer clearance from your work.



Eklind Ergo-Fold™ Key Sets can be used at a right angle to generate maximum torque. Additionally, they can be used as a screwdriver, with the key folded out to a firm stop. As with all other Eklind Hex Key products, we use the highest quality 8650 Chrome Nickel Alloy Hex Steel that is heat treated for superior strength and finished to resist rust. Eklind keys provide maximum torque and wear resistance.

INCH, METRIC AND TORX® SETS

A variety of inch and metric sets are available in both regular Hex and Ball-Hex series. Small, medium and large size handles offer the proper amount of torque for the application.

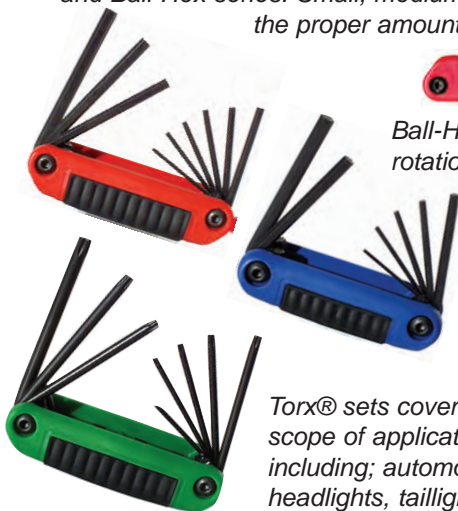

Ball-Hex Sets offer 360 degrees of rotation at up to a 35 degree angle.

Tamper Resistant - For "Pin in Socket" Torx® Fasteners.

Torx® sets cover a wide scope of applications including; automotive headlights, taillights and trim, power tools, carbide inserts in cutting tools, appliances and electronics.



COMBO SETS



SCREWDRIVER SETS

These convenient sets are ideal in the glove compartment and kitchen or desk drawers.



As Strong As Steel...Guaranteed Forever!

TORX® tools drive all TORX®, TORX PLUS® and "star" fasteners. TORX® and TORX PLUS® are registered trademarks of the Camcar Division of Textron, Inc.



Eklind ERGO-FOLD™ COMBO SETS



Eklind ERGO-FOLD™ KEY SETS

		KEY SETS							
ITEM NO.	NO. of KEYS	13213	13609	25161	25171	25561	25611	25911	25912
25013	13			Blue	Blue				
25015	15						Red		Red
25016	16			Blue	Blue			Red	
25024	24			Blue	Blue	Green		Red	
25028	28			Blue	Blue		Red		Red
25036	36			Blue	Blue	Green	Red		Red
29016	16		Blue		Blue				
29022	22	Red						Red	



Eklind ERGO-FOLD™ INCH SETS

			KEY SIZES													
ITEM NO.	Handle Size	NO. of KEYS	.050	1/16	5/64	3/32	7/64	1/8	9/64	5/32	3/16	7/32	1/4	5/16	3/8	
BALL-END INCH SETS																
25519	5.25	5									Red	Red	Red	Red	Red	Red
25919	4.25	9		Red	Red	Red	Red	Red	Red	Red	Red	Red	Red	Red	Red	Red
HEX INCH SETS																
25611	5.25	6							Red	Red	Red	Red	Red	Red	Red	Red
25911	4.25	9		Red	Red	Red	Red	Red	Red	Red	Red	Red	Red	Red	Red	Red
25912	3.63	9	Red	Red	Red	Red	Red	Red	Red	Red	Red	Red	Red	Red	Red	Red



Eklind ERGO-FOLD™ METRIC SETS

			KEY SIZES									
ITEM NO.	Handle Size	NO. of KEYS	1.5	2.0	2.5	3.0	4.0	5.0	6.0	7.0	8.0	10.0
BALL-END METRIC SETS												
25159	5.25	5				Blue	Blue	Blue	Blue		Blue	Blue
25169	3.00	6		Blue	Blue	Blue	Blue	Blue	Blue		Blue	Blue
HEX METRIC SETS												
25161	5.25	6				Blue	Blue	Blue	Blue		Blue	Blue
25171	3.63	7	Blue	Blue	Blue	Blue	Blue	Blue	Blue		Blue	Blue
25172	4.25	7		Blue	Blue	Blue	Blue	Blue	Blue		Blue	Blue
25181	4.25	8		Blue	Blue	Blue	Blue	Blue	Blue		Blue	Blue



Eklind ERGO-FOLD™ TORX® & SCREWDRIVER SETS

			KEY SIZES																			
ITEM NO.	Handle Size	NO. of KEYS	1/8" FB	3/16" FB	1/4" FB	#1 PB	AWL	4.0mm	5.0mm	6.0mm	T6	T7	T8	T9	T10	T15	T20	T25	T27	T30	T40	
25581	4.25	8										Green	Green	Green	Green	Green	Green	Green	Green	Green	Green	Green
25582	3.00	8									Green	Green	Green	Green	Green	Green	Green	Green	Green	Green	Green	Green
TAMPER RESISTANT TORX® SETS																						
25570	4.25	7													Green	Green	Green	Green	Green	Green	Green	Green
SCREWDRIVER SETS																						
25461	3.63	6	Yellow	Yellow	Yellow	Yellow	Yellow	Yellow	Yellow	Yellow	Yellow	Yellow	Yellow	Yellow	Yellow	Yellow	Yellow	Yellow	Yellow	Yellow	Yellow	Yellow
25651	3.63	5	Yellow	Yellow	Yellow	Yellow	Yellow	Yellow	Yellow	Yellow	Yellow	Yellow	Yellow	Yellow	Yellow	Yellow	Yellow	Yellow	Yellow	Yellow	Yellow	Yellow



CLASSIC FOLD-UP SETS

This versatile line of tools is available in inch and metric Hex Keys, Ball-Hex Keys, Torx® Keys or Screwdriver Bits. Each set of keys is housed in a one-piece comfort grip handle designed to operate smoothly as well as hold the keys firmly in any desired work position.

INCH AND METRIC SETS



A variety of Hex and Ball-Hex Sets are available, covering the full range of inch and metric sizes

TORX® SETS



Torx® sets cover a wide scope of applications including; automotive headlights, taillights and trim, power tools, carbide inserts in cutting tools, appliances and electronics.

COMBINATION SETS



SCREWDRIVER SETS

These convenient sets offer flat blades, #1 Phillips, a scratch awl and the popular T15 Torx® Key. They are easily kept in the glove compartment and kitchen or desk drawers.



TORX® tools drive all TORX®, TORX PLUS® and "star" fasteners. TORX® and TORX PLUS® are registered trademarks of the Camcar Division of Textron, Inc.



Eklind® CLASSIC FOLD-UP COMBO SETS



Eklind® CLASSIC FOLD-UP KEY SETS

			KEY SETS		
ITEM NO.	NO. of KEYS		20911	21171	22571
26160	16				
29171	23				



Eklind® CLASSIC FOLD-UP INCH SETS

			KEY SIZES													
ITEM NO.	Handle Size	NO. of KEYS	.050	1/16	5/64	3/32	7/64	1/8	9/64	5/32	3/16	7/32	1/4	5/16	3/8	
BALL-END INCH SETS																
20519	5.25	5														
20719	3.00	7														
20919	4.25	9														
HEX INCH SETS																
20511	5.25	5														
20811	3.00	8														
20812	5.25	8														
20911	4.25	9														
20912	3.63	9														



Eklind® CLASSIC FOLD-UP METRIC SETS

			KEY SIZES								
ITEM NO.	Handle Size	NO. of KEYS	1.5	2.0	2.5	3.0	4.0	5.0	6.0	8.0	10.0
BALL-END METRIC SETS											
21158	3.00	5									
21159	5.25	5									
HEX METRIC SETS											
21151	5.25	6									
21171	3.63	7									
21172	4.25	7									



Eklind® TORX® & SCREWDRIVER SETS

			KEY SIZES																			
ITEM NO.	Handle Size	NO. of KEYS	1/8" FB	3/16" FB	1/4" FB	1# PB	Awl	4.0mm	5.0mm	6.0mm	T6	T7	T8	T9	T10	T15	T20	T25	T27	T30	T40	
22571	4.25	7																				
22572	3.00	7																				
SCREWDRIVER SETS																						
22451	3.63	5																				
22461	3.63	6																				
22651	3.63	5																				



BALL•HEX•L™

BALL•HEX•L™ KEY SETS



Eklind Ball-Hex-L™ Keys are designed with a ball profile on the long arm. This feature provides 360 degrees of rotation at up to a 35 degree angle. The burr-free short arm allows the user to apply maximum torque in required applications. Sets are contained in a compact molded holder that firmly retains each key in designated holes. The molded holders are color-coded, red for inch sizes and blue for metric sizes.

Eklind Ball-Hex-L™ Key Sets are available in a variety of inch and metric sizes. Each set is contained in a convenient compact molded holder that firmly retains each key in designated holes. The molded holders are color coded which makes them instantly identifiable; red for inch sizes, and blue for metric sizes.

BALL•HEX•L™ COMBINATION SETS

Combination Sets are available in popular inch and metric sizes and in Ball-Hex-L™ or Ball-Hex-L™ and Ergo-Fold™ Sets.



URNS 360°
AT UP TO A
35° ANGLE



BALL•TORX® KEY SETS

The short arm has a standard Torx® tip. The long arm has a ball tip which is engineered to drive the Torx® fastener at up to a 35 degree angle.

TORX® tools drive all TORX®, TORX PLUS® and "star" fasteners. TORX® and TORX PLUS® are registered trademarks of the Camcar Division of Textron, Inc.



Eklind® BALL-HEX-L™ COMBO SETS

KEY SETS

ITEM NO.	NO. of KEYS	13211	13213	13607	13609	25171	25911
13218	18	✓		✓			
13222	22		✓		✓		
29016	16				✓	✓	
29022	22		✓				✓



Eklind® BALL-HEX-L™ INCH SETS

KEY SIZES

ITEM NO.	NO. of KEYS	.050	1/16	5/64	3/32	7/64	1/8	9/64	5/32	3/16	7/32	1/4	5/16	3/8	
IN MOLDED PLASTIC HOLDERS															
13207	7		✓	✓	✓	✓	✓	✓	✓	✓	✓	✓	✓	✓	
13211	11	✓	✓	✓	✓	✓	✓	✓	✓	✓	✓	✓	✓	✓	
13212	12	✓	✓	✓	✓	✓	✓	✓	✓	✓	✓	✓	✓	✓	
13213	13	✓	✓	✓	✓	✓	✓	✓	✓	✓	✓	✓	✓	✓	
13297	7		✓	✓	✓	✓	✓	✓	✓	✓	✓	✓	✓	✓	



Eklind® BALL-HEX-L™ METRIC SETS

KEY SIZES

ITEM NO.	NO. of KEYS	1.5	2.0	2.5	3.0	4.0	5.0	6.0	8.0	10.0
IN MOLDED PLASTIC HOLDER										
13607	7	✓	✓	✓	✓	✓	✓	✓	✓	✓
13609	9	✓	✓	✓	✓	✓	✓	✓	✓	✓



Eklind® BALL / TORX® SETS

KEY SIZES

ITEM NO.	NO. of KEYS	T10	T15	T20	T25	T27	T30	T40
IN MOLDED PLASTIC HOLDER								
10007	7	✓	✓	✓	✓	✓	✓	✓



Eklind®



HEX-L® & TORX® SETS

Eklind L-Keys are produced from 8650 Chrome Nickel Alloy Steel. They are heat treated for maximum strength and finished to resist rust. Eklind's superior quality provides maximum torque and prevents rounding out of the key or hex socket.

HEX-L® AND TORX® L-KEY SETS / MOLDED HOLDERS Eklind

HEX-L® KEY SETS

A variety of inch and metric sets are available in both short and long arm series. These sets are contained in a convenient compact molded holder that firmly retains each key in designated holes. The molded holders are color-coded which makes them instantly identifiable; red for inch sizes, and blue for metric sizes.



TORX® L★ KEY SETS

Torx® L- Key Sets are available in popular sizes and in both short or long arm series. They are conveniently contained in a green molded plastic holder with individually sized marked holes. Torx® keys are useful in the following applications: automotive headlights, taillights and trim, power tools, carbide inserts in cutting tools, appliances and electronics.



Tamper Resistant Torx® for "pin in socket" Torx® fasteners.



COMBINATION HEX-L® KEY SETS

A variety of Combination Hex-L® Key Sets are available in popular inch and metric sizes. These sets are contained in separate color-coded molded holders offering convenient, organized tools.



TORX® tools drive all TORX®, TORX PLUS® and "star" fasteners. TORX® and TORX PLUS® are registered trademarks of the Camcar Division of Textron, Inc.



Eklind® HEX-L® COMBO SETS

KEY SETS

ITEM NO.	SERIES	NO. of KEYS	10111	10113	10213	10507	10509	10609
10022	L & S	22			=====		=====	
10222	LONG	22			=====		=====	=====
10122	SHORT	22	=====				=====	
10518	SHORT	18	=====			=====		



Eklind® HEX-L® INCH SETS

KEY SIZES

ITEM NO.	SERIES	NO. of KEYS	.050	1/16	5/64	3/32	7/64	1/8	9/64	5/32	3/16	7/32	1/4	5/16	3/8	
IN MOLDED PLASTIC HOLDERS																
10018	SHORT LONG	18	S	S L	S L	S L	S	S L	L	S L	S L	S	L	L		
10107	SHORT	7		=====	=====			=====		=====	=====	=====				
10111	SHORT	11	=====	=====	=====	=====	=====	=====	=====	=====	=====	=====	=====			
** 10112	SHORT	12	=====	=====	=====	=====	=====	=====	=====	=====	=====	=====	=====	=====		
10113	SHORT	13	=====	=====	=====	=====	=====	=====	=====	=====	=====	=====	=====	=====		
10207	LONG	7		=====	=====			=====		=====	=====	=====				
10211	LONG	11	=====	=====	=====	=====	=====	=====	=====	=====	=====	=====	=====			
** 10212	LONG	12	=====	=====	=====	=====	=====	=====	=====	=====	=====	=====	=====	=====		
10213	LONG	13	=====	=====	=====	=====	=====	=====	=====	=====	=====	=====	=====	=====		

**AVAILABLE IN BULK ONLY (NO BLISTER PACK)



Eklind® HEX-L® METRIC SETS

KEY SIZES

ITEM NO.	SERIES	NO. of KEYS	1.5	2.0	2.5	3.0	4.0	5.0	6.0	8.0	10.0
IN MOLDED PLASTIC HOLDERS											
10507	SHORT	7	=====	=====	=====	=====	=====	=====	=====		
10509	SHORT	9	=====	=====	=====	=====	=====	=====	=====		
10607	LONG	7	=====	=====	=====	=====	=====	=====	=====		
10609	LONG	9	=====	=====	=====	=====	=====	=====	=====		



Eklind® TORX® L*SETS

KEY SIZES

ITEM NO.	SERIES	NO. of KEYS	T10	T15	T20	T25	T27	T30	T40
IN MOLDED PLASTIC HOLDERS									
10807	SHORT	7	=====	=====	=====	=====	=====	=====	
10907	LONG	7	=====	=====	=====	=====	=====	=====	
* 10707	TR	7	=====	=====	=====	=====	=====	=====	

*TAMPER RESISTANT



L-KEY METAL BOX SETS

Eklind L-Keys are produced from 8650 Chrome Nickel Alloy Steel. They are heat treated for maximum strength and finished to resist rust. Eklind's superior quality provides maximum torque and prevents rounding out of the key or hex socket.



A variety of Inch, Metric and Torx® sets make up this extensive line. Keys are housed into a sturdy metal case that will conveniently hang in the workshop or stand on the workbench. All sets are contained in an index for easy access. Box labels are color-coded, red for inch sizes, blue for metric sizes and green for Torx® sizes.

TORX® tools drive all TORX®, TORX PLUS® and "star" fasteners. TORX® and TORX PLUS® are registered trademarks of the Camcar Division of Textron, Inc.



Eklind® HEX-L® INCH SETS

ITEM NO.	SERIES	NO. of KEYS	KEY SIZES																	
			.028	.035	.050	1/16	5/64	3/32	7/64	1/8	9/64	5/32	3/16	7/32	1/4	5/16	3/8	1/2	9/16	5/8
BALL-HEX-L™ INCH SETS																				
13216	LONG	16																		
13293	LONG	13																		
HEX-L® INCH SETS																				
10115	SHORT	15																		
10118	SHORT	18																		
10214	LONG	14																		
10217	LONG	17																		
10294	LONG	14																		



Eklind® HEX-L® METRIC SETS

ITEM NO.	SERIES	NO. of KEYS	KEY SIZES														
			0.7	0.9	1.3	1.5	2.0	2.5	3.0	4.0	5.0	6.0	8.0	10.0	12.0	14.0	17.0
BALL-HEX-L™ METRIC SETS																	
13610	LONG	10															
13613	LONG	13															
HEX-L® METRIC SETS																	
10512	SHORT	12															
10515	SHORT	15															
10610	LONG	10															
10611	LONG	11															
10614	LONG	14															



Eklind® TORX® L*SETS

ITEM NO.	SERIES	NO. of KEYS	KEY SIZES														
			T6	T7	T8	T9	T10	T15	T20	T25	T27	T30	T40	T45	T50	T55	T60
10812	SHORT	12															
10890	SHORT	10															
10984	SHORT	14															
10912	LONG	12															
10990	LONG	10															
10994	LONG	14															



Eklind®



HEX•L® & TORX® SETS IN VINYL POUCHES

HEX-L® AND TORX® KEY SETS / VINYL POUCHES Eklind



Eklind L-Keys are manufactured using the finest 8650 alloy steel. They are heat treated for maximum strength and finished to resist rust. Hex corners are sharp and clean. Each key is square cut and burr free for full depth precision fit with the hex socket. Eklind's quality provides maximum torque and prevents rounding out of the key or hex socket.

A variety of inch, metric and Torx® sets are available in both short and long arm series. These sets are available in a sturdy, see through vinyl pouch that can fit compactly into a toolbox or hang in the workshop. The vinyl pouches are color-coded which makes them instantly identifiable.



 **TAMPER**
 **RESISTANT**

For "Pin in Socket"
Hex and Torx®
Fasteners.

Torx® keys are useful in the following applications: automotive headlights, taillights and trim, power tools, carbide inserts in cutting tools, appliances and electronics.





Eklind® HEX-L® INCH SETS

KEY SIZES

ITEM NO.	SERIES	NO. of KEYS	.028	.035	.050	1/16	5/64	3/32	7/64	1/8	9/64	5/32	3/16	7/32	1/4	5/16	3/8	7/16	1/2	9/16	5/8	3/4	
IN VINYL POUCHES																							
10311	6 INCH	11																					
10407	12 INCH	7																					
** 69113	SHORT	13																					
69207	SHORT	7																					
69211	SHORT	11																					
** 69213	LONG	13																					
69215	SHORT	15																					
69209	LONG	9																					
69218	S & L	18		S	S	S	S	S	S	S	S	S	S	S	S	S	S	S	S	S	S	S	S
87170	SHORT	20																					
* 90100	TR	8																					

* TAMPER RESISTANT

** WITH PLASTIC RING



Eklind® HEX-L® METRIC SETS

KEY SIZES

ITEM NO.	SERIES	NO. of KEYS	0.7	0.9	1.3	1.5	2.0	2.5	3.0	4.0	5.0	6.0	7.0	8.0	9.0	10.0	11.0	12.0	14.0	17.0	19.0	
IN VINYL POUCHES																						
10592	SHORT	12																				
69205	SHORT	7																				
69210	SHORT	10																				
** 69511	SHORT	11																				
** 69611	LONG	11																				
87169	SHORT	17																				

** WITH PLASTIC RING



Eklind® TORX® L*SETS

KEY SIZES

ITEM NO.	SERIES	NO. of KEYS	T6	T7	T8	T9	T10	T15	T20	T25	T27	T30	T40	T45	T50	T55
REGULAR TORX® IN VINYL POUCHES																
10014	BALL	14														
10714	TR	14														
10810	SHORT	10														
10814	SHORT	14														
10897	SHORT	7														
10910	LONG	10														
10914	LONG	14														
10997	LONG	7														

* TAMPER RESISTANT



L-KEY ORGANIZERS

These tough, four drawer / 22 compartment organizers come complete with one shelf pack quantity of each of the sizes contained in the series. Assortments are available in Hex-L®, Ball-Hex-L™ (inch & metric sizes) and Torx® L-Keys in both short and long series.



Eklind BALL-HEX-L™ AND HEX-L® ORGANIZERS

ITEM NO.	SERIES	NO. of PCS.	KEY SIZES																					
			.050	1/16	5/64	3/32	7/64	1/8	9/64	5/32	3/16	7/32	1/4	5/16	3/8	1.5	2.0	2.5	3.0	4.0	5.0	6.0		
45155	SHORT	425	25	25	25	25	25	25	25	25	25	10	10	5	5	25	25	25	25	25	25	10		
45256	LONG	425	25	25	25	25	25	25	25	25	25	10	10	5	5	25	25	25	25	25	25	10		
48286	BALL	200	10	10	10	10	10	10	10	10	10	10	10	5	5	10	10	10	10	10	10	10		



Eklind TORX® L★ KEY ORGANIZERS

ITEM NO.	SERIES	NO. of PCS.	KEY SIZES													
			T5	T6	T7	T8	T9	T10	T15	T20	T25	T27	T30	T40	T45	
40059	LONG	110	5	5	5	5	5	10	10	10	10	10	10	10	10	5

TORX® tools drive all TORX®, TORX PLUS® and "star" fasteners.



BALL•HEX•DRIVERS™

Ball-Hex-Drivers™ provide 360 degrees of rotation at up to a 35 degree angle. Large diameter tools have bigger handles for better grip and superior torque. Small diameter tools feature a precision style handle with a finger rest at the top. Handles and pouches are color coded; red for inch sizes and blue for metric sizes



This universal stand will accommodate a wide variety of Eklind products (T-Keys and Ball-Hex-Drivers™) in inch and metric sizes. They can be attached to a wall, to a bench or to each other.



Eklind BALL•HEX•DRIVER™ INCH SETS

		KEY SIZES												
ITEM NO.	NO. of KEYS	.050	1/16	5/64	3/32	7/64	1/8	9/64	5/32	3/16	7/32	1/4	5/16	3/8
SETS IN STANDS														
90114	13													
SETS IN POUCHES														
90113	13													
90108	8													
90109	9													



Eklind BALL•HEX•DRIVER™ METRIC SETS

		KEY SIZES									
ITEM NO.	NO. of KEYS	1.3	1.5	2.0	2.5	3.0	4.0	5.0	6.0	8.0	10.0
SETS IN STANDS											
90611	10										
SETS IN POUCHES											
90609	9										
90607	7										

Eklind BALL•HEX•DRIVER™ SETS



POWER-T™ KEY SETS

Eklind Power-T™ Keys feature an ergonomic, textured, slip-resistant grip which provides extra torque and safety. Our keys are manufactured from the highest quality hex steel, heat treated for maximum strength and finished to resist rust.

- ◆ **STRENGTH**
- ◆ **COMFORT**
- ◆ **SAFETY**

Power-T™ Keys are available in Standard Hex, (6" & 9" shaft lengths), Ball-Hex (9" shaft lengths), and Torx® (6" shaft lengths). Hex and Ball-Hex Keys are offered in popular inch and metric sizes.

This universal stand will accommodate a wide variety of Eklind products (Inch, Metric and Torx®). They can be attached to a wall to a bench, or to each other.



★ *Drives both Torx® & Torx Plus® Fasteners. Applications include automotive headlights, taillights and trim, power tools, carbide inserts in cutting tools, appliances and electronics.*

The Ball-Hex Keys are designed with greater length allowing access to hard to reach fasteners, and providing 360 degrees of rotation at up to a 35 degree angle. Ball-Hex tips are provided on all sizes from 5/64" and 2mm on up.

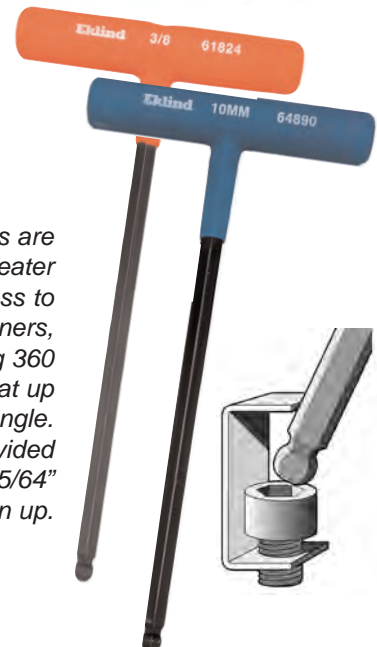

Handles and pouches are color-coded; red for inch sizes, blue for metric sizes, and green for Torx® sizes.

TORX® tools drive all TORX®, TORX PLUS® and "star" fasteners. TORX® and TORX PLUS® are registered trademarks of the Camcar Division of Textron, Inc.



Eklind® POWER-T™ INCH SETS



Eklind® POWER-T™ KEY SETS

ITEM NO.	TIP	ARM	NO. of KEYS	KEY SIZES												
				.050	1/16	5/64	3/32	7/64	1/8	9/64	5/32	3/16	7/32	1/4	5/16	3/8
SETS IN STANDS																
60814	BALL	9"	13	*	*											
60614	HEX	6"	13	*	*											
60914	HEX	9"	13	*	*											
SETS IN POUCHES																
60809	BALL	9"	9													
60811	BALL	9"	11													
60609	HEX	6"	9													
60611	HEX	6"	11													
60909	HEX	9"	9													
60911	HEX	9"	11													

*INDICATES L-KEY



Eklind® POWER-T™ METRIC SETS

ITEM NO.	TIP	ARM	NO. of KEYS	KEY SIZES											
				1.3	1.5	2.0	2.5	3.0	4.0	5.0	6.0	8.0	10.0		
SETS IN STANDS															
64811	BALL	9"	10	*	*										
64611	HEX	6"	10	*	*										
64911	HEX	9"	10	*	*										
SETS IN POUCHES															
64806	BALL	9"	6												
64808	BALL	9"	8												
64606	HEX	6"	6												
64608	HEX	6"	8												
64906	HEX	9"	6												
64908	HEX	9"	8												

*INDICATES L-KEY



Eklind® POWER-T™ TORX® SETS

ITEM NO.	TIP	ARM	NO. of KEYS	KEY SIZES											
				T6	T7	T8	T9	T10	T15	T20	T25	T27	T30	T40	T45
SETS IN STANDS															
68692	Torx®	6"	11												
SETS IN POUCHES															
68688	Torx®	6"	8												
68689	Torx®	6"	8												
68691	Torx®	6"	11												



HEX T-KEY SETS

These HexT-Keys feature a one piece loop handle construction for extra strength. Sets are available in bench sets with stand. Pouch sets fit compactly into a toolbox or hang in the workshop. Popular inch and metric sets are available in both 6" and 9" lengths. Cushion Grip Sets provide extra comfort. Standard Grip Sets offer a more economical option.





Eklind CUSHION GRIP INCH SETS

KEY SIZES

ITEM NO.	Arm Length	NO. of KEYS	KEY SIZES											
			3/32	7/64	1/8	9/64	5/32	3/16	7/32	1/4	5/16	3/8		
SETS IN STANDS														
50160	6"	10												
50190	9"	10												
SETS IN POUCHES														
53610	6"	10												
53910	9"	10												
53168	6"	8												
53198	9"	8												



Eklind CUSHION GRIP METRIC SETS

KEY SIZES

ITEM NO.	Arm Length	NO. of KEYS	KEY SIZES									
			2.0	2.5	3.0	4.0	5.0	6.0	8.0	10.0		
SETS IN STANDS												
56168	6"	8										
56198	9"	8										
SETS IN POUCHES												
55168	6"	8										
55198	9"	8										
55166	6"	6										
55196	9"	6										



Eklind STANDARD GRIP INCH SETS

KEY SIZES

ITEM NO.	Arm Length	NO. of KEYS	KEY SIZES											
			3/32	7/64	1/8	9/64	5/32	3/16	7/32	1/4	5/16	3/8		
SETS IN STANDS														
30160	6"	10												
30190	9"	10												
SETS IN POUCHES														
33610	6"	10												
33910	9"	10												
33168	6"	8												
33198	9"	8												



Eklind STANDARD GRIP METRIC SETS

KEY SIZES

ITEM NO.	Arm Length	NO. of KEYS	KEY SIZES										
			2.0	2.5	3.0	4.0	5.0	6.0	8.0	10.0			
SETS IN STANDS													
36168	6"	8											
36198	9"	8											
SETS IN POUCHES													
35168	6"	8											
35198	9"	8											
35165	6"	5											
35195	9"	5											





Eklind

INDIVIDUAL BALL-HEX-L™ KEYS



INDIVIDUAL BALL-HEX-L™ KEYS Eklind

Item No.	Dimensions		
	Tip Size	Long Arm	Short Arm
Ball-Hex-L™ Keys - Inch Sizes			
18203	.050	2.84	0.53
18204	1/16	3.00	0.56
18205	5/64	3.19	0.61
18206	3/32	3.38	0.66
18207	7/64	3.56	0.70
18208	1/8	3.75	0.75
18209	9/64	3.94	0.80
18210	5/32	4.12	0.84
18212	3/16	4.50	0.94
18214	7/32	4.88	1.03
18216	1/4	5.25	1.12
18220	5/16	6.00	1.25
18224	3/8	6.75	1.38
18228	7/16	7.50	1.50
18232	1/2	8.25	1.63
18236	9/16	9.00	1.75
18240	5/8	9.75	1.88
18248	3/4	11.25	2.13
18256	7/8	12.75	2.38
18264	1	14.25	2.63
Ball-Hex-L™ Keys - Metric Sizes			
18602	1.3	2.84	0.53
18603	1.5	3.03	0.53
18604	2.0	3.19	0.61
18605	2.5	3.48	0.69
18606	3.0	3.88	0.75
18607	3.5	4.00	0.84
18608	4.0	4.09	0.94
18609	4.5	4.34	1.00
18610	5.0	4.57	1.06
18611	5.5	5.01	1.13
18612	6.0	5.43	1.22
18614	7.0	6.20	1.38
18616	8.0	6.20	1.38
18618	9.0	6.58	1.54
18620	10.0	6.58	1.54
18622	11.0	7.50	1.50
18624	12.0	8.23	1.73
18628	14.0	9.15	2.15
18634	17.0	9.69	2.42
18638	19.0	10.85	2.70
18644	22.0	10.85	2.70
18648	24.0	14.25	2.63

Item No.	Dimensions		
	Tip Size	Long Arm	Short Arm
Ball / Torx® L-Keys - Long Series			
15006	T6	2.77	0.46
15007	T7	2.82	0.51
15008	T8	2.99	0.56
15009	T9	3.19	0.61
15010	T10	3.38	0.66
15015	T15	3.57	0.71
15020	T20	3.75	0.75
15025	T25	3.94	0.80
15027	T27	4.13	0.85
15030	T30	4.50	0.94
15040	T40	4.88	1.03
15045	T45	5.25	1.13
15050	T50	6.00	1.25
15055	T55	6.75	1.38
15060	T60	8.25	1.63



**TURNS 360°
AT UP TO A
35° ANGLE**



INDIVIDUAL TORX® L-KEYS



EKLIND
INDIVIDUAL TORX® L-KEY KEYS

Item No.	Dimensions		
	Tip Size	Long Arm	Short Arm
Torx® L-Keys - Short Series			
15805	T5	1.54	0.46
15806	T6	1.59	0.46
15807	T7	1.64	0.51
15808	T8	1.74	0.56
15809	T9	1.88	0.61
15810	T10	2.00	0.66
15815	T15	2.13	0.71
15820	T20	2.25	0.75
15825	T25	2.38	0.80
15827	T27	2.50	0.85
15830	T30	2.75	0.94
15840	T40	3.00	1.03
15845	T45	3.25	1.13
15850	T50	3.75	1.25
15855	T55	4.25	1.38
15860	T60	5.25	1.63
Torx® L-Keys - Long Series			
15905	T5	2.72	0.46
15906	T6	2.77	0.46
15907	T7	2.82	0.51
15908	T8	2.99	0.56
15909	T9	3.19	0.61
15910	T10	3.38	0.66
15915	T15	3.57	0.71
15920	T20	3.75	0.75
15925	T25	3.94	0.80
15927	T27	4.13	0.85
15930	T30	4.50	0.94
15940	T40	4.88	1.03
15945	T45	5.25	1.13
15950	T50	6.00	1.25
15955	T55	6.75	1.38
15960	T60	8.25	1.63



Item No.	Dimensions		
	Tip Size	Long Arm	Short Arm
Tamper Resistant Torx® L-Keys - Long Series			
15706	T6	2.77	0.46
15707	T7	2.82	0.51
15708	T8	2.99	0.56
15709	T9	3.19	0.61
15710	T10	3.38	0.66
15715	T15	3.57	0.71
15720	T20	3.75	0.75
15725	T25	3.94	0.80
15727	T27	4.13	0.85
15730	T30	4.50	0.94
15740	T40	4.88	1.03
15745	T45	5.25	1.13
15750	T50	6.00	1.25
15755	T55	6.75	1.38
15760	T60	8.25	1.63

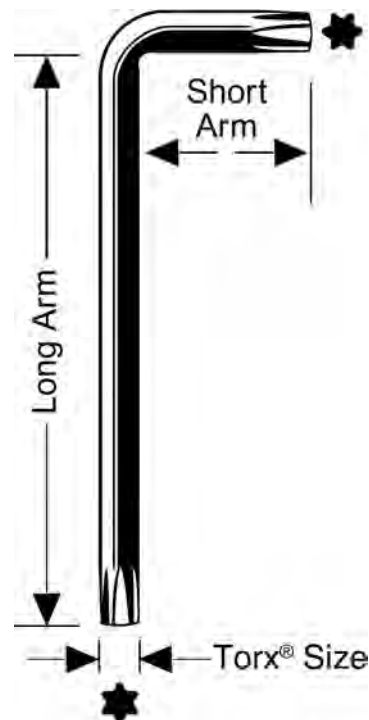
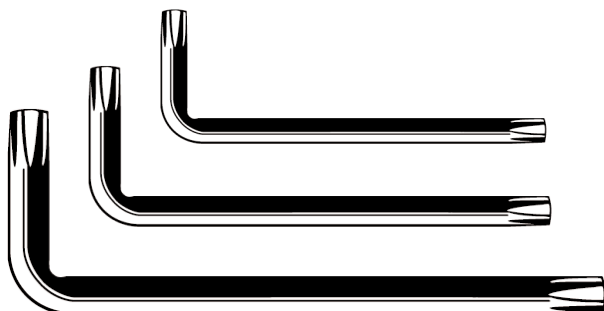



INDIVIDUAL HEX-L® KEYS / INCH SIZES



INDIVIDUAL HEX-L® KEYS / INCH SIZES Eklind

Item No.	Dimensions		
	Tip Size	Long Arm	Short Arm
Hex-L® Keys - Inch Sizes - Short Series			
15101	.028	1.22	0.22
15102	.035	1.22	0.34
15103	.050	1.66	0.53
15104	1/16	1.75	0.56
15105	5/64	1.88	0.61
15106	3/32	2.00	0.66
15107	7/64	2.12	0.70
15108	1/8	2.25	0.75
15109	9/64	2.38	0.80
15110	5/32	2.50	0.84
15112	3/16	2.75	0.94
15114	7/32	3.00	1.03
15116	1/4	3.25	1.12
15120	5/16	3.75	1.25
15124	3/8	4.25	1.38
15128	7/16	4.75	1.50
15132	1/2	5.25	1.63
15136	9/16	5.75	1.75
15140	5/8	6.25	1.88
15148	3/4	7.25	2.13
15156	7/8	8.25	2.38
15164	1	9.25	2.63
15166	1 1/8	10.25	2.75
Mega Hex - 4140 Grade Steel			
15168	1 1/4	12.11	4.80
15172	1 1/2	13.25	3.50
15176	1 3/4	15.25	4.00
15180	2	17.25	4.50
Hex-L® Keys - Inch Sizes - 6" Series			
15305	5/64	6.00	0.61
15306	3/32	6.00	0.66
15307	7/64	6.00	0.70
15308	1/8	6.00	0.75
15309	9/64	6.00	0.80
15310	5/32	6.00	0.84
15312	3/16	6.00	0.94
15314	7/32	6.00	1.03
15316	1/4	6.00	1.12
15320	5/16	6.00	1.25
15324	3/8	6.00	1.38

Item No.	Dimensions		
	Tip Size	Long Arm	Short Arm
Hex-L® Keys - Inch Sizes - Long Series			
15201	.028	2.60	0.22
15202	.035	2.67	0.34
15203	.050	2.84	0.53
15204	1/16	3.00	0.56
15205	5/64	3.19	0.61
15206	3/32	3.38	0.66
15207	7/64	3.56	0.70
15208	1/8	3.75	0.75
15209	9/64	3.94	0.80
15210	5/32	4.12	0.84
15212	3/16	4.50	0.94
15214	7/32	4.88	1.03
15216	1/4	5.25	1.12
15220	5/16	6.00	1.25
15224	3/8	6.75	1.38
15228	7/16	7.50	1.50
15232	1/2	8.25	1.63
15236	9/16	9.00	1.75
15240	5/8	9.75	1.88
15248	3/4	11.25	2.13
15256	7/8	12.75	2.38
15264	1	14.25	2.63
15266	1 1/8	15.75	2.75
Mega Hex - 4140 Grade Steel			
15268	1 1/4	19.80	4.80
15272	1 1/2	20.25	3.50
15276	1 3/4	23.25	4.00
15280	2	26.38	4.50
Hex-L® Keys - Inch Sizes - 12" Series			
15405	5/64	12.00	0.61
15406	3/32	12.00	0.66
15408	1/8	12.00	0.75
15410	5/32	12.00	0.84
15412	3/16	12.00	0.94
15414	7/32	12.00	1.03
15416	1/4	12.00	1.12
Tamper Resistant Hex-L® Keys - Inch Sizes			
90206	3/32	5.25	1.00
90208	1/8	5.25	1.00
90210	5/32	5.25	1.20
90212	3/16	5.25	1.20
90214	7/32	5.25	1.20
90216	1/4	5.25	1.38
90220	5/16	5.25	1.38
90224	3/8	5.25	1.38





INDIVIDUAL HEX-L® KEYS / METRIC SIZES



EKLIND INDIVIDUAL HEX-L® KEYS / METRIC SIZES

Item No.	Dimensions		
	Tip Size	Long Arm	Short Arm
Hex-L® Keys - Metric Sizes - Short Series			
15500	0.7	1.22	0.22
15501	0.9	1.22	0.34
15502	1.3	1.63	0.53
15503	1.5	1.73	0.53
15504	2.0	1.93	0.61
15505	2.5	2.15	0.69
15506	3.0	2.42	0.75
15507	3.5	2.54	0.84
15508	4.0	2.68	0.94
15509	4.5	2.86	1.00
15510	5.0	3.08	1.06
15511	5.5	3.26	1.13
15512	6.0	3.46	1.22
15514	7.0	3.65	1.38
15516	8.0	3.84	1.38
15518	9.0	4.07	1.54
15520	10.0	4.29	1.54
15522	11.0	4.75	1.50
15524	12.0	4.80	1.73
15528	14.0	5.37	2.15
15534	17.0	6.14	2.42
15538	19.0	6.91	2.70
15544	22.0	8.25	2.70
15548	24.0	9.25	2.63
15551	27.0	9.61	3.84
Mega Hex - 4140 Grade Steel			
15556	32.0	12.11	4.80
15560	36.0	13.64	5.37

Item No.	Dimensions		
	Tip Size	Long Arm	Short Arm
Hex-L® Keys - Metric Sizes - Long Series			
15600	0.7	2.60	0.22
15601	0.9	2.67	0.34
15602	1.3	2.84	0.53
15603	1.5	3.03	0.53
15604	2.0	3.19	0.61
15605	2.5	3.48	0.69
15606	3.0	3.88	0.75
15607	3.5	3.98	0.84
15608	4.0	4.09	0.94
15609	4.5	4.32	1.00
15610	5.0	4.57	1.06
15611	5.5	4.99	1.13
15612	6.0	5.43	1.22
15614	7.0	6.20	1.38
15616	8.0	6.20	1.38
15618	9.0	6.58	1.54
15620	10.0	6.58	1.54
15622	11.0	7.50	1.50
15624	12.0	8.23	1.73
15628	14.0	9.15	2.15
15634	17.0	9.69	2.42
15638	19.0	10.85	2.70
15644	22.0	10.85	2.70
15648	24.0	14.25	2.63
15651	27.0	16.26	3.84
Mega Hex - 4140 Grade Steel			
15656	32.0	19.80	4.80
15660	36.0	22.21	5.37

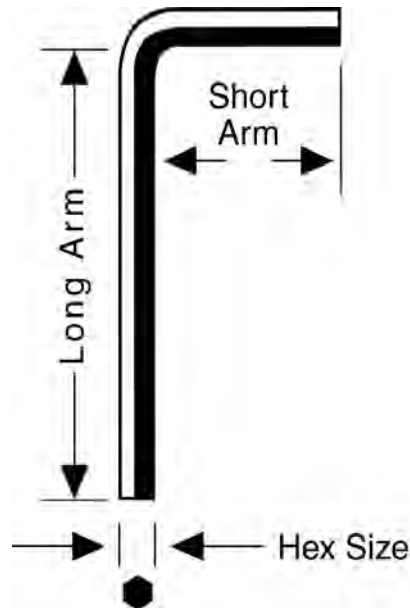



Eklind

INDIVIDUAL POWER-T™ KEYS



INDIVIDUAL POWER-T™ KEYS Eklind

Item No.	Dimensions		
	Tip Size	Handle Width (in)	Shaft Length (in)
Power-T™ Torx® Keys - 6" Series			
68606	T6	3	6
68607	T7	3	6
68608	T8	3	6
68609	T9	3	6
68610	T10	3	6
68615	T15	3	6
68620	T20	3	6
68625	T25	3	6
68627	T27	4	6
68630	T30	4	6
68640	T40	4	6
68645	T45	5	6
68650	T50	5	6
Power-T™ Ball-Hex Keys - Inch Sizes - 9" Series			
61805	5/64	2	9
61806	3/32	2	9
61807	7/64	2	9
61808	1/8	3	9
61809	9/64	3	9
61810	5/32	3	9
61812	3/16	4	9
61814	7/32	4	9
61816	1/4	4	9
61820	5/16	5	9
61824	3/8	5	9
Power-T™ Ball-Hex Keys - Metric Sizes - 9" Series			
64820	2.0	2	9
64825	2.5	2	9
64830	3.0	3	9
64840	4.0	3	9
64850	5.0	4	9
64860	6.0	4	9
64870	7.0	5	9
64880	8.0	5	9
64885	9.0	5	9
64890	10.0	5	9

Item No.	Dimensions		
	Tip Size	Handle Width (in)	Shaft Length (in)
Power-T™ Hex Keys - Inch Sizes - 6" Series			
61605	5/64	3	6
61606	3/32	3	6
61607	7/64	3	6
61608	1/8	3	6
61609	9/64	3	6
61610	5/32	3	6
61612	3/16	4	6
61614	7/32	4	6
61616	1/4	4	6
61620	5/16	5	6
61624	3/8	5	6
Power-T™ Hex Keys - Inch Sizes - 9" Series			
61905	5/64	3	9
61906	3/32	3	9
61907	7/64	3	9
61908	1/8	3	9
61909	9/64	3	9
61910	5/32	3	9
61912	3/16	4	9
61914	7/32	4	9
61916	1/4	4	9
61920	5/16	5	9
61924	3/8	5	9
Power-T™ Hex Keys - Metric Sizes - 6" Series			
64620	2.0	3	6
64625	2.5	3	6
64630	3.0	3	6
64640	4.0	3	6
64650	5.0	4	6
64660	6.0	4	6
64670	7.0	5	6
64680	8.0	5	6
64685	9.0	5	6
64690	10.0	5	6
Power-T™ Hex Keys - Metric Sizes - 9" Series			
64920	2.0	3	9
64925	2.5	3	9
64930	3.0	3	9
64940	4.0	3	9
64950	5.0	4	9
64960	6.0	4	9
64970	7.0	5	9
64980	8.0	5	9
64985	9.0	5	9
64990	10.0	5	9

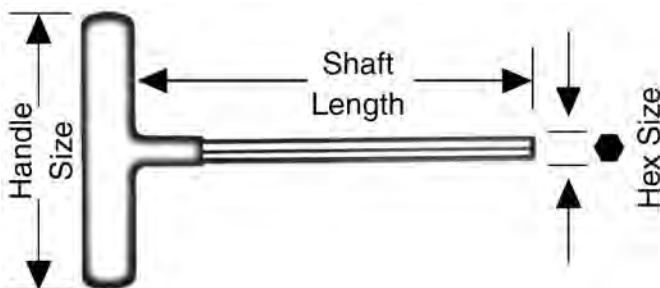

TORX® tools drive all TORX®, TORX PLUS® and "star" fasteners. TORX® and TORX PLUS® are registered trademarks of the Camcar Division of Textron, Inc.



INDIVIDUAL HEX T-KEYS



EKLIND

INDIVIDUAL HEX T-KEYS

Item No.	Dimensions		
	Tip Size	Handle Width (in)	Shaft Length (in)
Cushion Grip Hex T-Keys - Inch Sizes - 6" Series			
51605	5/64	3	6
51606	3/32	3	6
51607	7/64	3	6
51608	1/8	3	6
51609	9/64	3	6
51610	5/32	3	6
51612	3/16	4	6
51614	7/32	4	6
51616	1/4	4	6
51620	5/16	6	6
51624	3/8	6	6
51628	7/16	6	6
51632	1/2	6	6
Cushion Grip Hex T-Keys - Inch Sizes - 9" Series			
51905	5/64	3	9
51906	3/32	3	9
51907	7/64	3	9
51908	1/8	3	9
51909	9/64	3	9
51910	5/32	3	9
51912	3/16	4	9
51914	7/32	4	9
51916	1/4	4	9
51920	5/16	6	9
51924	3/8	6	9
51928	7/16	6	9
51932	1/2	6	9
Cushion Grip Hex T-Keys - Metric Sizes - 6" Series			
54620	2.0	3	6
54625	2.5	3	6
54630	3.0	3	6
54640	4.0	3	6
54650	5.0	4	6
54660	6.0	4	6
54680	8.0	6	6
54690	10.0	6	6
54691	11.0	6	6
54692	12.0	6	6
Cushion Grip Hex T-Keys - Metric Sizes - 9" Series			
54920	2.0	3	9
54925	2.5	3	9
54930	3.0	3	9
54940	4.0	3	9
54950	5.0	4	9
54960	6.0	4	9
54980	8.0	6	9
54990	10.0	6	9
54991	11.0	6	9
54992	12.0	6	9

Item No.	Dimensions		
	Tip Size	Handle Width (in)	Shaft Length (in)
Standard Grip Hex T-Keys - Inch Sizes - 3" Series			
31305	5/64	3	3
31306	3/32	3	3
31307	7/64	3	3
31308	1/8	3	3
31309	9/64	3	3
31310	5/32	3	3
31312	3/16	4	3
31314	7/32	4	3
31316	1/4	4	3
31320	5/16	6	3
31324	3/8	6	3
Standard Grip Hex T-Keys - Inch Sizes - 6" Series			
31605	5/64	3	6
31606	3/32	3	6
31607	7/64	3	6
31608	1/8	3	6
31609	9/64	3	6
31610	5/32	3	6
31612	3/16	4	6
31614	7/32	4	6
31616	1/4	4	6
31620	5/16	6	6
31624	3/8	6	6
Standard Hex T-Keys - Inch Sizes - 9" Series			
31905	5/64	3	9
31906	3/32	3	9
31907	7/64	3	9
31908	1/8	3	9
31909	9/64	3	9
31910	5/32	3	9
31912	3/16	4	9
31914	7/32	4	9
31916	1/4	4	9
31920	5/16	6	9
31924	3/8	6	9
Standard Grip Hex T-Keys - Metric Sizes - 6" Series			
34620	2.0	3	6
34625	2.5	3	6
34630	3.0	3	6
34640	4.0	3	6
34650	5.0	4	6
34660	6.0	4	6
34680	8.0	6	6
34690	10.0	6	6
Standard Grip Hex T-Keys - Metric Sizes - 9" Series			
34920	2.0	3	9
34925	2.5	3	9
34930	3.0	3	9
34940	4.0	3	9
34950	5.0	4	9
34960	6.0	4	9
34980	8.0	6	9
34990	10.0	6	9

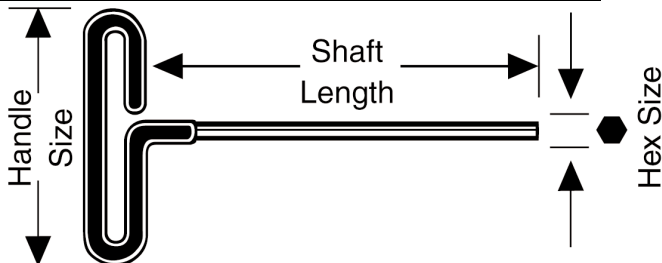



Eklind® INDIVIDUAL BALL-HEX DRIVERS™

INDIVIDUAL BALL-HEX DRIVERS™ / UNIVERSAL HEX KEY STAND Eklind

Item No.	Dimensions		
	Tip Size	Handle Size	Shaft Length (in)
Ball-Hex Screwdrivers - Inch Sizes			
91103	.050	P	3.0
91104	1/16	P	3.0
91105	5/64	P	3.0
91106	3/32	P	3.0
91107	7/64	P	3.0
91108	1/8	S	5.4
91109	9/64	S	5.4
91110	5/32	M	5.6
91112	3/16	M	5.6
91114	7/32	M	5.6
91116	1/4	L	5.8
91120	5/16	L	5.8
91124	3/8	L	5.8
91128	7/16	L	5.8
91132	1/2	L	5.8

Item No.	Dimensions		
	Tip Size	Handle Size	Shaft Length (in)
Ball-Hex Screwdrivers - Metric Sizes			
91602	1.3	P	3.0
91603	1.5	P	3.0
91604	2.0	P	3.0
91605	2.5	S	3.0
91606	3.0	S	3.0
91608	4.0	M	5.4
91610	5.0	M	5.4
91612	6.0	L	5.6
91616	8.0	L	5.6
91620	10.0	L	5.6
91624	12.0	L	5.8



Item No.	Dimensions		
	Width	Height	Depth
Universal Hex Key Stand			
11111	7.50	6.00	5.50

This universal stand will accommodate a wide variety of Eklind products (Inch, Metric and Torx®). They can be attached to a wall to a bench, or to each other.

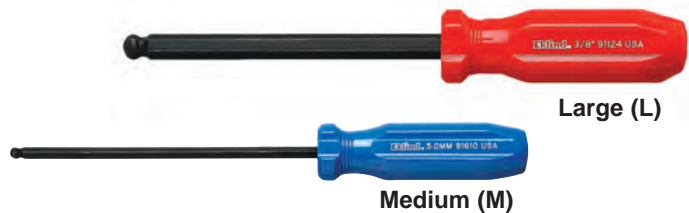
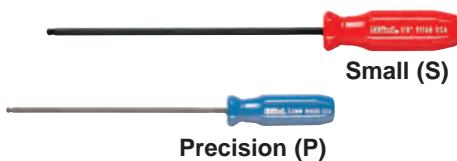
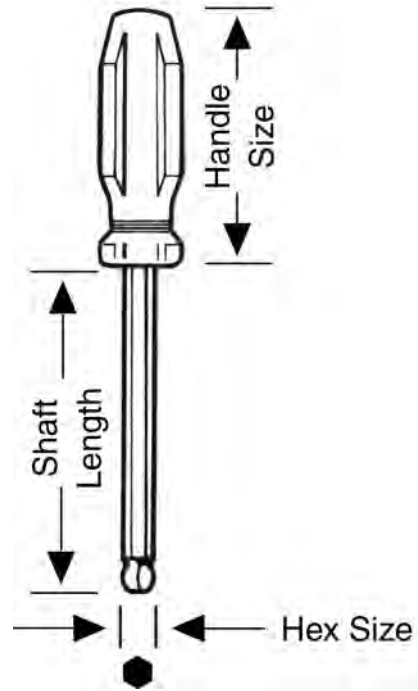



REPLACEMENT PARTS / SHAFTS



EKLIND REPLACEMENT PARTS / SHAFTS

Item No.	Dimensions	
	Size	Length
Ball-Hex - Inch Sizes		
62403	0.05	4.0
62404	1/16	4.0
62405	5/64	4.0
63805	5/64	9.4
62406	3/32	4.0
63806	3/32	9.4
62407	7/64	4.0
63807	7/64	9.4
62808	1/8	6.4
63808	1/8	9.4
62809	9/64	6.4
63809	9/64	9.4
62810	5/32	6.4
63810	5/32	9.4
62812	3/16	6.6
63812	3/16	9.6
62814	7/32	6.6
63814	7/32	9.6
62816	1/4	6.8
63816	1/4	9.8
62820	5/16	6.8
63820	5/16	9.8
62824	3/8	6.8
63824	3/8	9.8
62828	7/16	9.1
62832	1/2	10.0
Ball Hex - Metric Sizes		
65413	1.3	4.0
65415	1.3	4.0
65420	2.0	4.0
66820	2.0	9.4
65425	2.5	4.0
66825	2.5	9.4
65830	3.0	6.4
66830	3.0	9.4
65840	4.0	6.4
66840	4.0	9.4
65850	5.0	6.6
66850	5.0	9.6
65860	6.0	6.8
66860	6.0	9.8
65880	8.0	6.8
66880	8.0	9.8
65890	10.0	6.8
66890	10.0	9.2
65895	12.0	10.0
Torx® Sizes		
67605	T5	6.4
67606	T6	6.4
67607	T7	6.4
67608	T8	6.4
67609	T9	6.4
67610	T10	6.4
67615	T15	6.4
67620	T20	6.4
67625	T25	6.4
67627	T27	6.6
67630	T30	6.6
67640	T40	6.8
67645	T45	6.8
67650	T50	6.8
67655	T55	6.8

Item No.	Dimensions	
	Size	Length
Standard Hex - Inch Sizes		
63605	5/64	6.4
63905	5/64	9.4
63606	3/32	6.4
63906	3/32	9.4
63607	7/64	6.4
63907	7/64	9.4
63608	1/8	6.4
63908	1/8	9.4
63609	9/64	6.4
63909	9/64	9.4
63610	5/32	6.4
63910	5/32	9.4
63612	3/16	6.6
63912	3/16	9.6
63614	7/32	6.6
63914	7/32	9.6
63616	1/4	6.8
63916	1/4	9.8
63620	5/16	6.8
63920	5/16	9.8
63624	3/8	6.8
63924	3/8	9.8
Standard Hex - Metric Sizes		
66620	2.0	6.4
66920	2.0	9.4
66625	2.5	6.4
66925	2.5	9.4
66630	3.0	6.4
66930	3.0	9.4
66640	4.0	6.4
66940	4.0	9.4
66650	5.0	6.6
66950	5.0	9.6
66660	6.0	6.8
66960	6.0	9.8
66680	8.0	6.8
66980	8.0	9.8
66690	10.0	6.8
66990	10.0	9.8

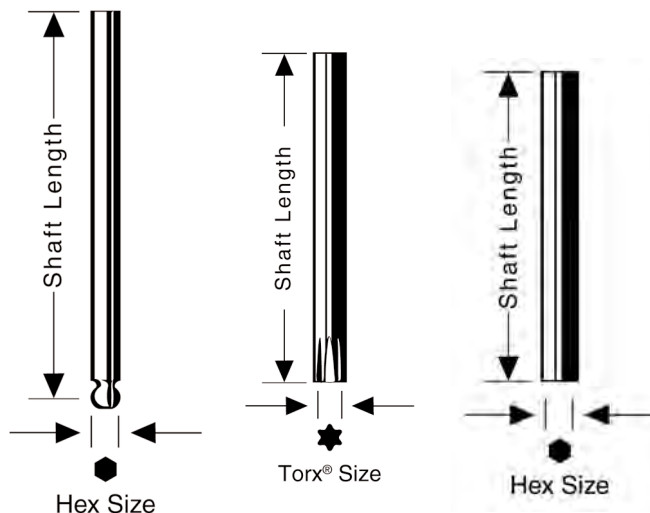



REPLACEMENT KEYS / FOLD-UP SETS



Item No.	Models																											
	Hex Size	Length	20511	20811	20812	20911	20912	20519	20719	20919	25611	25911	25912	25519	25919	21151	21171	21172	20719	20919	25161	25171	25172	25919				
Replacement Keys / Fold-Up Inch Sets																												
24031	.050	1.8		•			•						•															
24041	1/16	1.9		•			•						•															
24051	5/64	2.0		•		•	•					•	•															
24061	3/32	2.1		•		•	•					•	•															
28406	3/32	3.7			•																							
24071	7/64	2.3		•		•	•					•	•															
28407	7/64	3.8			•																							
24081	1/8	2.4		•		•	•					•	•															
28408	1/8	3.9			•																							
24091	9/64	2.6		•		•	•					•	•															
28409	9/64	4.1			•																							
24101	5/32	2.7		•		•	•					•	•															
28410	5/32	4.2			•																							
24121	3/16	2.9					•						•															
24122	3/16	3.3	•			•					•	•																
28412	3/16	4.7			•																							
24142	7/32	3.5	•			•						•																
28414	7/32	4.8			•							•																
24162	1/4	3.7	•			•						•																
28416	1/4	5.0			•																							
25202	5/16	4.8	•								•																	
25242	3/8	5.1	•								•																	
Replacement Keys / Fold-Up Inch Sets / Ball Series																												
26041	1/16	1.9							•																			
26051	5/64	2.0							•	•					•													
26061	3/32	2.1							•	•					•													
26071	7/64	2.3							•	•					•													
26081	1/8	2.4							•	•					•													
26091	9/64	2.6							•	•					•													
26101	5/32	2.7							•	•					•													
26122	3/16	3.3						•			•	•			•	•												
26142	7/32	3.5						•			•	•			•	•												
26162	1/4	3.7						•			•	•			•	•												
26202	5/16	4.8						•			•	•			•	•												
26242	3/8	5.1						•			•	•			•	•												
Replacement Keys / Fold-Up Metric Sets																												
29015	1.5	1.8															•						•					
29020	2.0	2.0															•		•				•		•			
29025	2.5	2.2															•		•				•		•			
29030	3.0	2.4															•		•				•		•			
29103	3.0	3.3															•						•		•			
29040	4.0	2.6															•		•				•		•			
29104	4.0	3.5															•		•				•		•			
29050	5.0	3.1															•		•				•		•			
29105	5.0	3.8															•		•				•		•			
29060	6.0	3.3															•		•				•		•			
29116	6.0	3.8															•		•				•		•			
29106	6.0	4.0															•		•				•		•			
29080	8.0	4.1															•		•				•		•			
29108	8.0	4.8															•		•				•		•			
29110	10.0	5.1															•		•				•		•			
Replacement Keys / Fold-Up Metric Sets / Ball Series																												
27015	1.5	1.8																										
27020	2.0	2.0																										
27025	2.5	2.2																										
27030	3.0	2.4																										
27040	4.0	2.6																										
27104	4.0	3.5																										
27105	5.0	3.8																										
27106	6.0	4.0																										
27108	8.0	4.8																										
27110	10.0	5.1																										

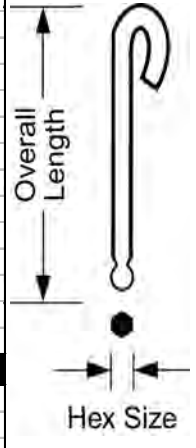
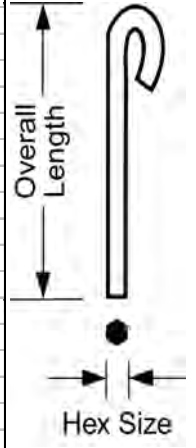



REPLACEMENT KEYS / FOLD-UP SETS



**EKLIND
REPLACEMENT PARTS**

Item No.	Models											
	Hex Size	Length	22451	22461	22571	22572	22651	25461	25570	25581	25582	25651
Replacement Keys / Fold-Up Torx® Sizes												
23061	T6	1.7				★					★	
23071	T7	1.8				★					★	
23081	T8	2.0				★					★	
23092	T9	2.1				★					★	
23010	T10	2.7							★			
23101	T10	2.7			★					★		
23102	T10	2.4				★					★	
23015	T15	3.0							★			
23151	T15	3.0	★		★			★		★		
23152	T15	2.5				★					★	
23020	T20	3.2							★			
23201	T20	3.2			★					★		
23202	T20	2.8				★					★	
23025	T25	3.4							★			
23251	T25	3.4			★					★		
23027	T27	3.5							★			
23271	T27	3.5			★					★		
23030	T30	3.7							★			
23301	T30	3.7			★					★		
23040	T40	4.0							★			
23401	T40	3.9			★					★		
Replacement Keys / Screwdriver Parts												
27120	1/8 FB	2.4	+	+				+				
27180	3/16 FB	2.7	+	+			+	+				+
27252	1/4 FB	3.2	+	+				+				
27181	#1 PB	3.1	+	+			+	+				+
27182	AWL	2.6	+	+				+				
29040	4mm	2.6					●					●
29050	5mm	3.1					●					●
29060	6mm	3.3					●					●



REPLACEMENT PARTS/MOLDED HOLDERS

Item No.	Models					
	Series	No. of Holes				
Replacement Holders / Hex-L® Key Sets						
19018	Inch	18	10018			
19107	Inch	7	10107	10207	13207	
19111	Inch	11	10111	10211	13211	
19113	Inch	13	10113	10213	13212	13213
19507	Metric	7	10507	10607	13607	
19509	Metric	9	10509	10609	13609	
19807	Torx®	7	10007	10707	10807	10907



METAL BOXES FOR L-KEYS

Item No.	Models	
	Description	
Metal Box for L-Keys		
19518	Holds up to 18 Short Series L-Keys (Inch, Metric or Torx)	
19618	Holds up to 18 Long Series L-Keys (Inch, Metric or Torx)	

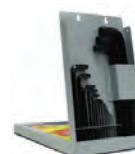

- Sturdy Metal Storage for L-Keys
- Hang it up
- Use it as a stand



MERCHANDISERS

These space saving displays are designed to showcase our most popular Hex Key Sets and come complete with product and all the necessary hardware. Product features and benefits are quickly identified by bright, bold graphics and key copy points. Displays can accommodate standard or scanner hooks.



PLAN-O-GRAMS

- ◆ PEGBOARD COMPATIBLE
- ◆ STURDY VINYL BACKERS
- ◆ INCLUDE REORDER TAGS
- ◆ AVAILABLE WITH STANDARD OR SCANNER HOOKS



DISPLAY RACKS

- ◆ STRONG WIRE RACK
- ◆ INCLUDE HOOKS
- ◆ INCLUDE REORDER TAGS
- ◆ CAN SIT ON COUNTER OR HANG ON PEGBOARD



MERCHANDISER BOX

- ◆ ATTRACTIVE DISPLAY BOX
- ◆ IDEAL FOR COUNTER DISPLAY



STRIPS

- ◆ HANGS ANYWHERE
- ◆ HIGH VISIBILITY

INCH SIZES								
Hex Size	CAP SCREWS					Set Screws	Shoulder Screws	Pressure Plug
	Socket Head 1936	Socket Head 1960	Flat Head	Button Head	Low Head			
.028						0		
.035			0	0		1, 2		
.050	0, 1	0	1, 2	1, 2	4	3, 4		
1/16	2	1	3, 4	3, 4	5, 6	5, 6		
5/64	3, 4	2, 3	5, 6	5, 6	8	8		
3/32	5, 6	4, 5	8	8	10	10		
7/64		6						
1/8	8		10	10	1/4	1/4	1/4	
9/64	10	8						
5/32	1/4	10	1/4	1/4	5/16	5/16	5/16	1/16
3/16	1/4	1/4	5/16	5/16	3/8	3/8	3/8	1/8
7/32	5/16		3/8	3/8	7/16	7/16		
1/4		5/16	7/16		1/2	1/2	1/2	1/4
5/16	3/8, 7/16	3/8	1/2	1/2	5/8	5/8	5/8	3/8
3/8	1/2	7/16, 1/2	5/8	5/8		3/4	3/4	1/2
7/16		9/16						
1/2	5/8	5/8	3/4			7/8	1	
9/16	3/4, 7/8		7/8			1, 1-1/8		3/4
5/8	1	3/4	1			1-1/4, 1-3/8	1-1/4	1
3/4	1-1/8, 1-1/4, 13/8	7/8, 1	1-1/8			1-1/2		1-1/4
7/8		1-1/8, 1-1/4	1-1/4, 1-3/8				1-1/2	
1	1-1/2	1-3/8, 1-1/2	1-1/2			1-3/4, 2	1-3/4	1-1/2, 2
1-1/4		1-3/4					2	
1-1/2		2						
1-3/4		2-1/4, 2-1/2						
2		2-3/4						

METRIC SIZES						
Hex Size	CAP SCREWS				Set Screws	Shoulder Screws
	Socket Head	Flat Head	Button Head	Low Head		
0.7					1.4, 1.6, 1.8	
0.9					2, 2.3	
1.3	1.4				2.5, 2.6	
1.5	1.6, 2				3	
2	2.5	3	3		4	
2.5	3	4	4		5	
3	4	5	5	4	6	5
4	5	6	6	5	8	6
5	6	8	8	6	10	8
6	8	10	10	8	12, 14	10
8	10	12	12	10	16	12
10	12	14, 16	14, 16	12	18, 20	16
12	14	18, 20	18, 20	14	22, 24	20
14	16, 18	22, 24	22, 24	16		
17	20, 22			20, 22		
19	24, 27			24		

TORX® SIZES				
Torx® Size	CAP SCREWS			Set Screws
	Socket Head	Flat Head	Button Head	
T6				M3
T7				#6
T8			#4	#8, M4
T9		#4		
T10	#4, #5, M3	#5, M3	#6, M3	#10, M5
T15	#6	#6	#8	
T20		#8, M4	M4	1/4, M6
T25	#8, M4	#10, M5	#10, M5	
T27	#10, M5		1/4	5/16, M8
T30	1/4, M6	1/4, M6	M6	3/8
T40		5/16, M8	5/16, M8	M10
T45	5/16, M8	3/8	3/8	1/2, M12
T50	3/8, M10	M10	M10	M14
T55	M12	5/8, M12	1/2, M12	M16
T60	M14	3/4, M16	5/8, M16	M20

Eklind Tool Company

11040 King Street • Franklin Park, IL, U.S.A. 60131-1432

800.373.1140 • fax 800.373.1108

www.eklindtool.com • e-mail sales@ekindtool.net